

OneFive ORIGAMI 03XP-3P

Triple wavelength UV femtosecond laser

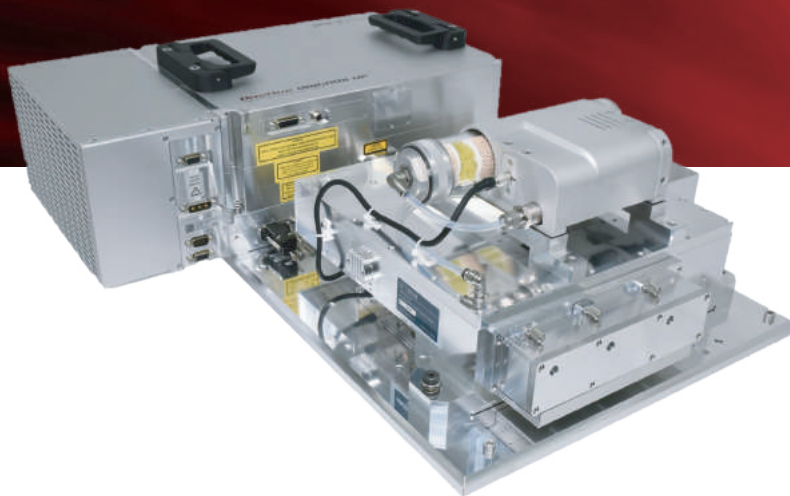

FEMTOSECOND IR, GREEN, AND UV

Flexible femtosecond micromachining

The ORIGAMI 03XP-3P is a triple wavelength femtosecond laser, allowing computer-controlled, flexible switching between IR, green or UV wavelengths in one laser system.

Based on the highly successful ORIGAMI XP platform, the same advantages of clean, femtosecond pulse output, excellent beam quality together with unprecedented beam stability are obtained by virtue of the Optocage™ laser design.

Applications

- **Foil cutting**
- **LCD patterning**
- **OLED display repair**
- **Flex PCB processing**
- **Medical device manufacturing**

OneFive ORIGAMI 03XP-3P

High reliability for industrial and medical applications

The ORIGAMI 03XP-3P has been designed with a focus on high reliability and unprecedented UV lifetime.

Easy availability of IR, green, and UV wavelengths ensure the user can process a variety of materials with the Origami 03XP-03.

The combination of multiple wavelengths together with clean femto-second pulse output allows efficient processing of materials where low HAZ is essential.

Features

- IR, green, and UV selectable output
- > 10,000 hours reliability
- < 300 fs UV pulse duration
- Single-shot or Pulse-on-demand
- Excellent pointing stability
- Superior beam quality
- In-field replaceable purge system
- Air or water cooled

TYPICAL OUTPUT PULSE WIDTH

Typical clean output pulse traces from the 03XP-3P showing a close fit to ideal (Sech²).

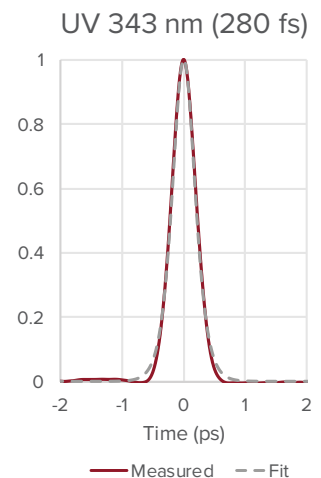
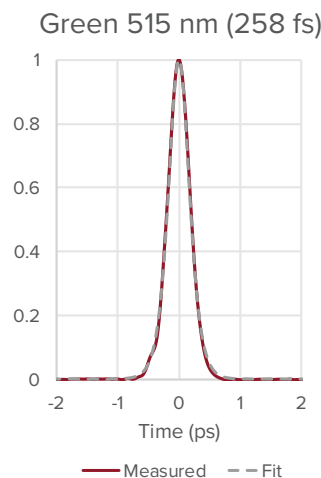
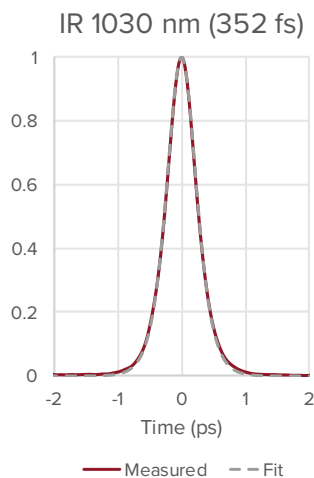

TYPICAL PULSE ENERGY AND OUTPUT POWER PERFORMANCE OF 03XP-3P

Performance optimized at 100 kHz

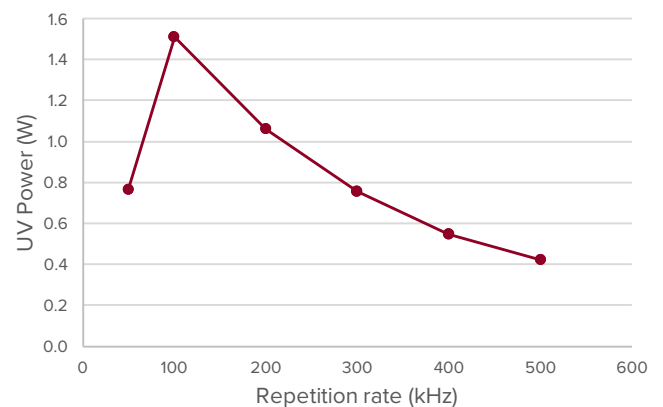
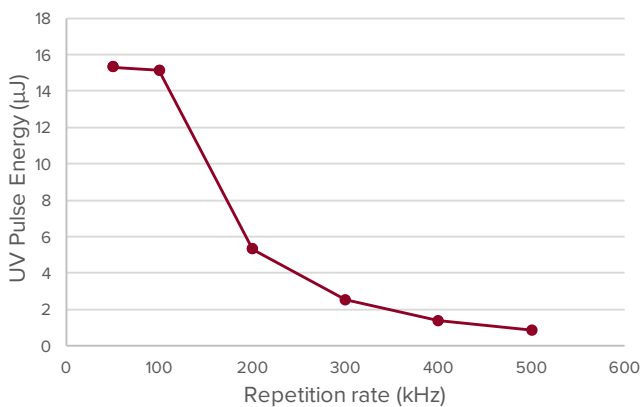
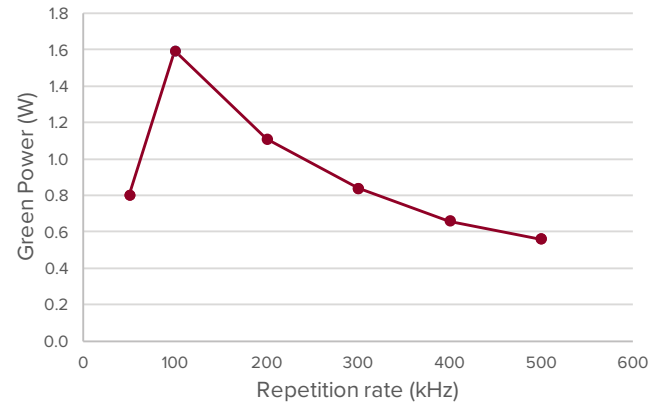
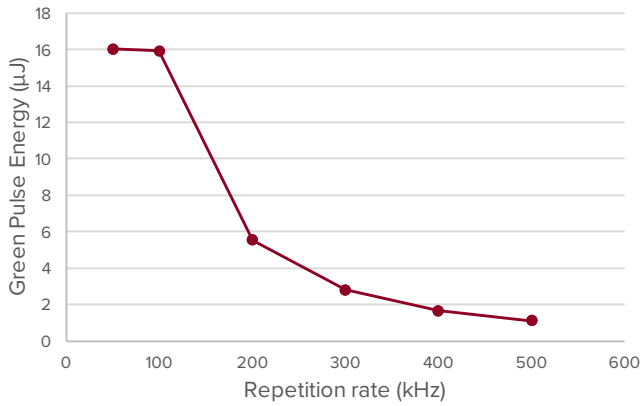
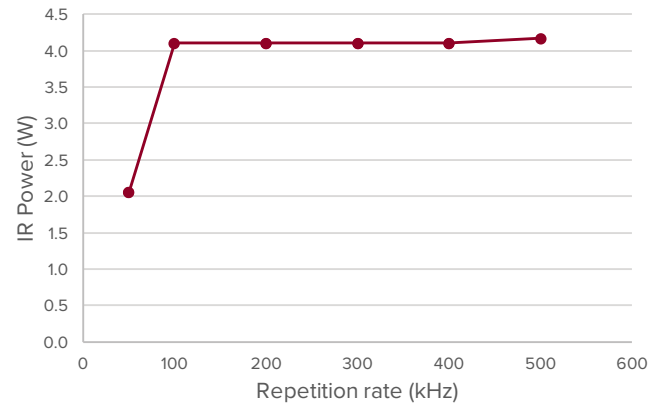
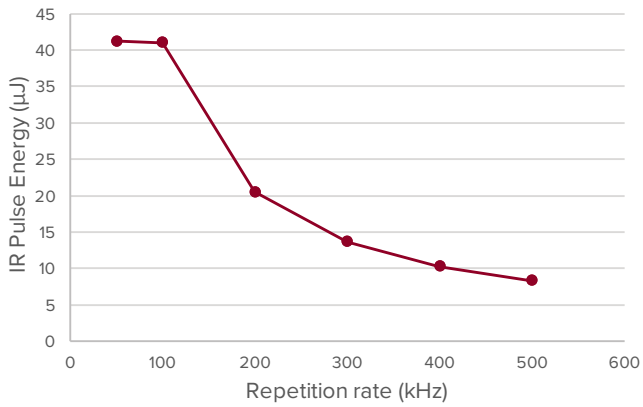

SPECIFICATIONS

| | | | |
|--------------------------------------|--|-----------------------|-----------------------|
| Model | 03XP-3P | | |
| Center wavelength [nm] | 1030 | 515 | 343 |
| Pulse duration [fs] | < 400 | < 350 | < 300 |
| Average power [W] | > 4 | > 1.5 | > 1.2 |
| Pulse energy [μ J] | 40 | 15 | 12 |
| Spectral bandwidth [nm] | < 5 | < 2 | < 1 |
| Pulse selection options | Single-shot to 1 MHz, Pulse-on-demand | | |
| Laser output | Collimated free-space | Collimated free-space | Collimated free-space |
| Beam quality (TEM_{00}) | $M^2 \leq 1.2$ | $M^2 \leq 1.3$ | $M^2 \leq 1.3$ |
| Polarization orientation | Horizontal | Horizontal | Vertical |
| Polarization / PER [dB] | > 23 | > 23 | > 23 |
| Beam diameter $\pm 10\%$ [mm] | 2.0 | 2.0 | 2.0 |
| Beam divergence (2σ) [mrad] | < 1.0 | < 1.0 | < 1.0 |
| Power stability [%] ¹⁾ | < 1 | < 1.5 | < 2 |
| Beam circularity ²⁾ | > 0.85 | > 0.85 | > 0.85 |
| Pointing stability | < 30 μ rad rms (12h), constant temperature < 5 μ rad/ $^{\circ}$ C 18-28 $^{\circ}$ C | | |
| Wavelength switching [s] | < 1 | < 1 | < 1 |

1) RMS, 12 h, constant temperature.

2) Measured at 300mm from aperture

SPECIFICATIONS

Mechanical/Electrical

| | |
|--------------------------------------|--|
| Laser output | Collimated free-space |
| Warm-up time [min.] | < 10 (warm start) < 30 (cold start) |
| Operation temperature [°C] | 18 – 28 |
| Storage temperature [°C] | -20 – 55 |
| Power supply requirements | 24 VDC/20A or 90-264 VAC, 47-63 Hz |
| Power consumption [W] | < 500 |
| Laser head dimensions (WxHxD) [mm] | 674.50 x 225.00 x 582.35 |
| Power supply dimensions (WxHxD) [mm] | 165 x 85 x 314 |
| Laser head weight [kg] | 55 |
| Cooling | Water or air |

Support and warranty

All ORIGAMI products come with an industry-leading reliability.

The product is covered by a comprehensive warranty. Service options are available. For details, please enquire.

MECHANICAL DRAWINGS

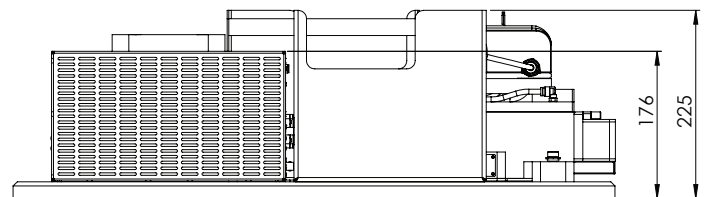
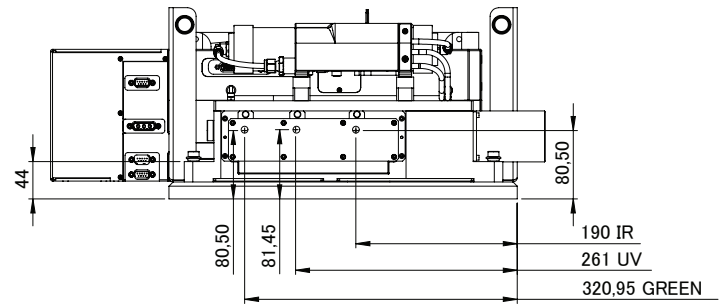
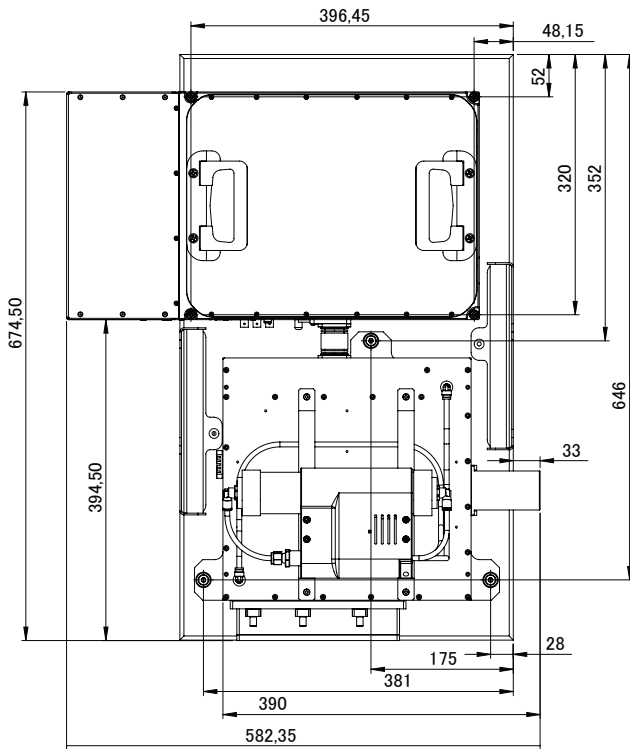

All ORIGAMI products are produced under our quality management system certified in accordance with the ISO 9001:2015 and ISO 13485:2016 standard.



CONTACT

OXIDE Corporation Yokohama Branch

11th Floor, Yokohama Business Park West Tower,
134, Godo-cho, Hodogaya-ku, Yokohama, Kanagawa,
240-0005 Japan

URL : <https://www.opt-oxide.com/>

TEL : +81-45-444-9511

E-mail : laser.sales@opt-oxide.com